

# *Eclipse Extern-A-Therm Recuperators*

*Models 300 MA - 2500 MA*



## **Copyright**

Copyright 2007 by Eclipse, inc. All rights reserved worldwide. This publication is protected by federal regulation and shall not be copied, distributed, transmitted, transcribed or translated into any human or computer language, in any form or by any means, to any third parties, without the express written consent of Eclipse, inc.

## **Disclaimer Notice**

In accordance with the manufacturer's policy of continual product improvement, the product presented in this brochure is subject to change without notice or obligation.

The material in this manual is believed adequate for the intended use of the product. If the product is used for purposes other than those specified herein, confirmation of validity and suitability must be obtained. Eclipse warrants that the product itself does not infringe upon any United States patents. No further warranty is expressed or implied.

## **Liability & Warranty**

We have made every effort to make this manual as accurate and complete as possible. Should you find errors or omissions, please bring them to our attention so that we may correct them. In this way we hope to improve our product documentation for the benefit of our customers. Please send your corrections and comments to our Technical Documentation Specialist.

It must be understood that Eclipse's liability for its product, whether due to breach of warranty, negligence, strict liability, or otherwise is limited to the furnishing of replacement parts and Eclipse will not be liable for any other injury, loss, damage or expenses, whether direct or consequential, including but not limited to loss of use,

income, or damage to material arising in connection with the sale, installation, use of, inability to use, or the repair or replacement of Eclipse's products.

Any operation expressly prohibited in this manual, any adjustment, or assembly procedures not recommended or authorized in these instructions shall void the warranty.

## **Document Conventions**

There are several special symbols in this document. You must know their meaning and importance.

The explanation of these symbols follows below. Please read it thoroughly.

## **How To Get Help**

If you need help, contact your local Eclipse representative. You can also contact Eclipse at:

1665 Elmwood Rd.  
Rockford, Illinois 61103 U.S.A.  
Phone: 815-877-3031  
Fax: 815-877-3336  
<http://www.eclipsenet.com>

Please have the information on the product label available when contacting the factory so we may better serve you.

 <b>ECLIPSE</b> <small>Innovative Thermal Solutions</small>	<a href="http://www.eclipsenet.com">www.eclipsenet.com</a>
Product Name	
Item #	
S/N	
DD MMM YYYY	



This is the safety alert symbol. It is used to alert you to potential personal injunt hazards. Obey all safety messages that follow this symbol to avoid possible injury or death.



Indicates a hazardous situation which, if not avoided, will result in death or serious injury.



Indicates a hazardous situation which, if not avoided, could result in death or serious injury.



Indicates a hazardous situation which, if not avoided, could result in minor or moderate injury.

**NOTICE**

Is used to address practices not related to personal injury.

**NOTE**

Indicates an important part of text. Read thoroughly.

---



# *Table of Contents*

<b>Introduction</b> .....	<b>4</b>
Product Description.....	4
<b>Safety</b> .....	<b>5</b>
Safety Warnings.....	5
Capabilities.....	5
Operator Training.....	5
Replacement Parts.....	5
<b>System Design</b> .....	<b>6</b>
Furnace Temperature Limits.....	6
Flue Gas Restrictions .....	6
Recuperator Sizing .....	7
Dilution Air .....	7
Number of Recuperators .....	7
Mounting the Recuperator .....	7
Mounting the Eductor.....	7
Typical Air Pipe Work .....	8
Eductor Air Flow .....	8
Cleaning the Recuperator .....	8

# Introduction

## Product Description

The Extern-A-Therm recuperators are compact tubular air-to-air heat exchangers designed to recover the waste heat in industrial exhaust gases. The recovered heat is used to preheat the combustion air for the system's burners, thereby increasing the thermal efficiency. To ensure that all the wasted heat is drawn across the recuperator tubes, the recuperator is typically mated with an Eclipse eductor.

The single-ended design of the Extern-A-Therm recuperator allows for free expansion of the recuperator tubes; no expansion joints are required.

The design of the Extern-A-Therm, housing and eductor ensure ease of installation and efficient use of existing pipe work. The housings are internally insulated; there is no need for additional external insulation.



Figure 1.1. Extern-A-Therm Recuperator

## Audience

This manual has been written for people who are already familiar with all aspects of industrial heating equipment design.

These aspects are:

- Design/Selection
- Use
- Maintenance

The audience is expected to have previous experience with this type of equipment.

## Extern-A-Therm Documents

### **Design Guide No. 540**

- This document

### **Datasheet, Series No. 540-1 through 540-4**

- Available for individual Extern-A-Therm models
- Required to complete design calculations in this guide

### **Related Documents**

- EFE 825 (Combustion Engineering Guide)
- Eclipse Bulletins and Info Guides: 610, 710, 720, 730, 742, 744, 760, 930

## Purpose

The purpose of this manual is to ensure that the design of a safe, effective, and trouble free system is carried out.

# Safety

Important notices which help provide safe burner operation will be found in this section. To avoid personal injury and damage to the property or facility, the following warnings must be observed. All involved personnel should read this entire manual carefully before attempting to start or operate this system. If any part of the information in this manual is not understood, contact Eclipse before continuing.

## Safety Warnings



### **DANGER**

- **The burners, described herein, are designed to mix fuel with air and burn the resulting mixture. All fuel burning devices are capable of producing fires and explosions if improperly applied, installed, adjusted, controlled or maintained.**
- **Do not bypass any safety feature; fire or explosion could result.**
- **Never try to light a burner if it shows signs of damage or malfunction.**



### **WARNING**

- **The burner and duct sections are likely to have HOT surfaces. Always wear the appropriate protective equipment when approaching the burner.**
- **Eclipse products are designed to minimize the use of materials that contain crystalline silica. Examples of these chemicals are: respirable crystalline silica from bricks, cement or other masonry products and respirable refractory ceramic fibers from insulating blankets, boards, or gaskets. Despite these efforts, dust created by sanding, sawing, grinding, cutting and other construction activities could release crystalline silica. Crystalline silica is known to cause cancer, and health risks from the exposure to these chemicals vary depending on the frequency and length of exposure to these chemicals. To reduce the risk, limit exposure to these chemicals, work in a well-ventilated area and wear approved personal protective safety equipment for these chemicals.**

### **NOTICE**

- **This manual provides information regarding the use of these burners for their specific design purpose. Do not deviate from any instructions or application limits described herein without written approval from Eclipse.**

## Capabilities

Only qualified personnel, with sufficient mechanical aptitude and experience with combustion equipment, should adjust, maintain or troubleshoot any mechanical or electrical part of this system. Contact Eclipse for any needed commissioning assistance.

## Operator Training

The best safety precaution is an alert and trained operator. Train new operators thoroughly and have them demonstrate an adequate understanding of the equipment and its operation. A regular retraining schedule should be administered to ensure operators maintain a high degree of proficiency. Contact Eclipse for any needed site-specific training.

## Replacement Parts

Order replacement parts from Eclipse only. All Eclipse approved valves or switches should carry UL, FM, CSA, CGA and/or CE approval where applicable.

# System Design

## Design

### Furnace Temperature Limits

**Up to 1800°F** - No special safeguards are required to protect the recuperator. See “Special Precautions for Aluminum Melting or Holding” on this page, for aluminum applications.

**1800°F - 2100°F** - To ensure that the safe operating temperature of the recuperator tubes is not exceeded, air flow must not fall below the following limits:

- Model 300 MA - 90 scfh
- Model 600 MA - 180 scfh
- Model 1500 MA - 450 scfh
- Model 2500 MA - 750 scfh

The recuperator must be positioned so that it will not be exposed to direct radiation from the furnace. This is to protect the recuperator during shut down or power failure.



- **When shutting a process down, air must be supplied to the exchanger until the exhaust inlet temperature falls below 1800°F.**

**2100°F - 2400°F** - Dilution air must be introduced to the air stream to maintain exhaust temperature below 2100°F. (See Figure 3.4.) The amount of dilution air can be determined from the “Dilution Air” section, page 7. When using dilution air do not operate with excess fuel, either gas or oil. The resulting fire would destroy the recuperator.

A high temperature protection limit switch must be fitted to ensure flue temperatures do not exceed 2100°F.

The recuperator must be positioned so that it will not be exposed to direct radiation from the furnace. This is to protect the recuperator during shutdown or power failure.

The low flow air requirements listed above must be observed.



- **When shutting a process down, air must be supplied to the exchanger until the exhaust inlet temperature falls below 1800°F.**

### Flue Gas Restrictions

The recuperator must not be used with any chloride, sulfide, potassium, sodium or lithium salts in the flue gas.

### Special Precautions for Aluminum Melting or Holding

If the recuperator is to be used on aluminum melting furnaces where flux is used, special precautions must be taken to protect the recuperator during the fluxing cycle. When flux is being used, the exit of the eductor should be closed off and a by-pass duct opened until the fluxing is complete and no fluxing agents are present in the exhaust. Closing the damper on the eductor will force the eductor air back through the recuperator ensuring that no contaminated exhaust gases enter the recuperator. See Figure 3.1.

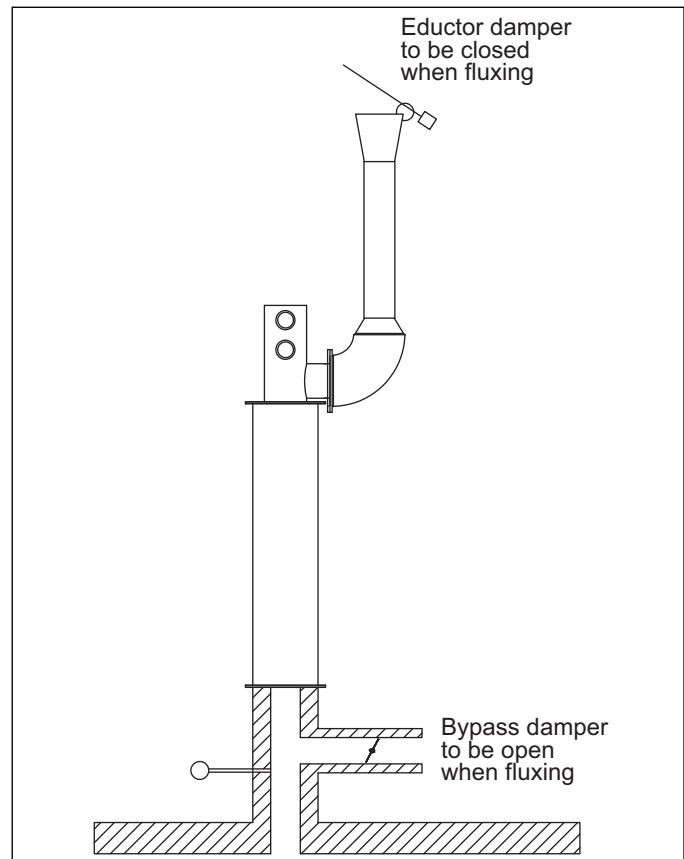

Figure 3.1.

In addition when using the recuperators on aluminum melting or holding furnaces, the exhaust temperature must be diluted to less than 1300°F (704°C). This will ensure that any aluminum in the exhaust will condense out before entering the recuperator. Aluminum condensing on the recuperator tubes will cause damage. When in doubt consult Eclipse.



- Failure to observe these conditions can destroy the recuperator and will void the warranty.

### Determine the Size of Recuperator Required

It is assumed that the net BTU requirement is known. The table below is an approximate guide for the efficiency with an Extern-A-Therm recuperator at various furnace temperatures with 10% excess combustion air. This is sufficiently accurate to determine the size of recuperator to use; it should not be used to determine actual gas usage.

Furnace Temperature °F (°C)	Efficiency with Extern-A-Therm Recuperator
1500 (815)	70%
1600 (817)	68.5%
1700 (926)	67%
1800 (982)	65.7%
1900 (1037)	64.4%
2000 (1093)	63%
2100 (1148)	60.6%
2200 (1204)	59.3%
2300 (1260)	58%

Calculate the gross BTU requirement using this efficiency, then check the Extern-A-Therm recuperator capacities in the datasheet to determine the size of recuperator.

#### Example:

Net required 1.0 mm BTU/hr with furnace temperature of 1700°F. Using the table above, the efficiency = 67%.

Therefore, the gross input = 1.0mm BTU/hr ÷ 0.67 = 1.49mm BTU/hr. From the datasheets, a 1500 MA Extern-A-Therm with a capacity of 0.4mm BTU/hr to 1.6mm BTU/hr must be used. If a higher preheated air temperature is required the 2500 MA should be used.

### Dilution Air

If the furnace temperature is above 2100°F dilution air must be introduced to cool the exhaust gases to 2100°F before they enter the recuperator.

As a guide, the following chart can be used to determine the amount of dilution air required.

Furnace Temp °F (°C)	Burner Capacity BTU/hr (kW)				
	100,000 (29.3)	200,000 (58.6)	500,000 (146.5)	1,000,000 (293.1)	2,000,000 (586.1)
2200 (1204)	75 (2.1)	150 (4.3)	375 (10.6)	730 (20.7)	1,460 (41.3)
2300 (1260)	150 (4.2)	300 (8.5)	750 (21.2)	1,500 (42.4)	3,000 (84.9)
2400 (1315)	220 (6.2)	440 (12.4)	1,100 (31.1)	2,200 (62.3)	4,400 (124.6)

Table Values for  
Volume scfh (m<sup>3</sup>/hr) Cooling Air

### Number of Extern-A-Therm Recuperators

It is recommended that one recuperator be used for each zone of control. This has the advantage that the combustion air flow is controlled on the cold side of the recuperator. All the subsequent instructions and descriptions are written with this assumption. If it is required that a single Extern-A-Therm recuperator will pre-heat the combustion air for multiple zones, consult Eclipse.

### Mounting the Recuperator

The Extern-A-Therm recuperators are designed for vertical mounting with the recuperator tubes hanging vertically down. If an alternative mounting arrangement is required, contact Eclipse.

The recuperator and exhaust housings have sufficient strength to be self supporting from the mounting flange, and can support the eductor if fitted. Eclipse recommends the use of flexible piping at the air inlet/outlet and entrainment air connections to accommodate expansion and contraction. See Figure 3.2 for a typical arrangement.

Do not add additional insulation to the outside of the recuperator, as this will damage the unit.

### Mounting the Eductor

The eductor can be mounted directly to the recuperator. The outlet flange on the recuperator is of sufficient strength to support the weight of the eductor; no additional support is required for the eductor.

The standard eductor is designed for vertical mounting, if horizontal mounting is required, consult Eclipse. No additional exhaust ducting should be connected directly to the eductor.

There should be no restrictions at the eductor outlet; this would affect the eductor performance. See Figure 3.3. The outside of the eductor should not be insulated.



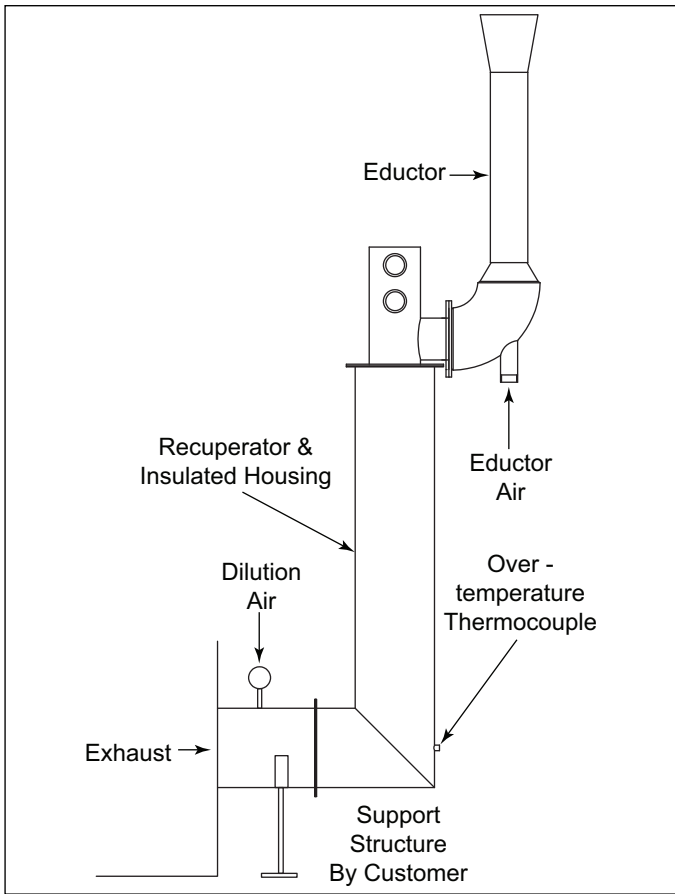

**Figure 3.2.**

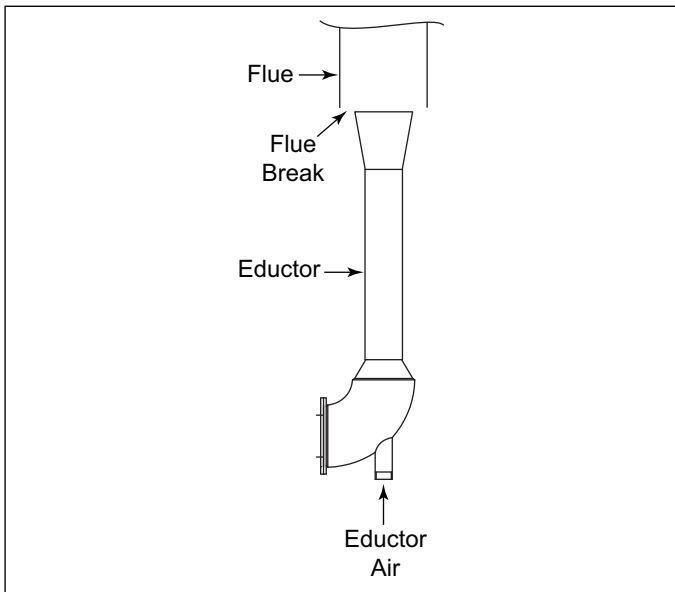

**Figure 3.3.**

## Typical Air Pipe Work

The schematic, Figure 3.4, shows a typical air control scheme. This uses one control valve to control the combustion air, eductor air and dilution air. As the burners turn down, the eductor air lowers to reduce the suction and keep the furnace at the desired pressure. If dilution air is necessary, this will also be reduced, so as not to excessively cool the exhaust gas. A more sophisticated control, Figure 3.5. This assumes that greater furnace pressure control is required. The eductor air has a separate control valve driven by the furnace pressure control.

More details of the combustion circuits and methods of controlling the air and gas can be found in Design Guide 206 covering ThermJet Burners for Preheated Combustion Air.

## Eductor Air Flow

Eductors are designed to overcome the exhaust gas pressure drop through the recuperator. The eductor airflows given in the datasheet are the flows required to overcome the exhaust pressure drop at the maximum rating of the recuperator and an inlet exhaust temperature of 1900°F (1037°C). The entrainment air flow required will be different at other capacities or exhaust temperatures.

## Cleaning the Recuperator

Dirt or other substances in the exhaust can accumulate on the outside of the recuperator tubes. Units can be cleaned with steam, compressed air, or any other method that accomplishes the task without damaging the insulation.



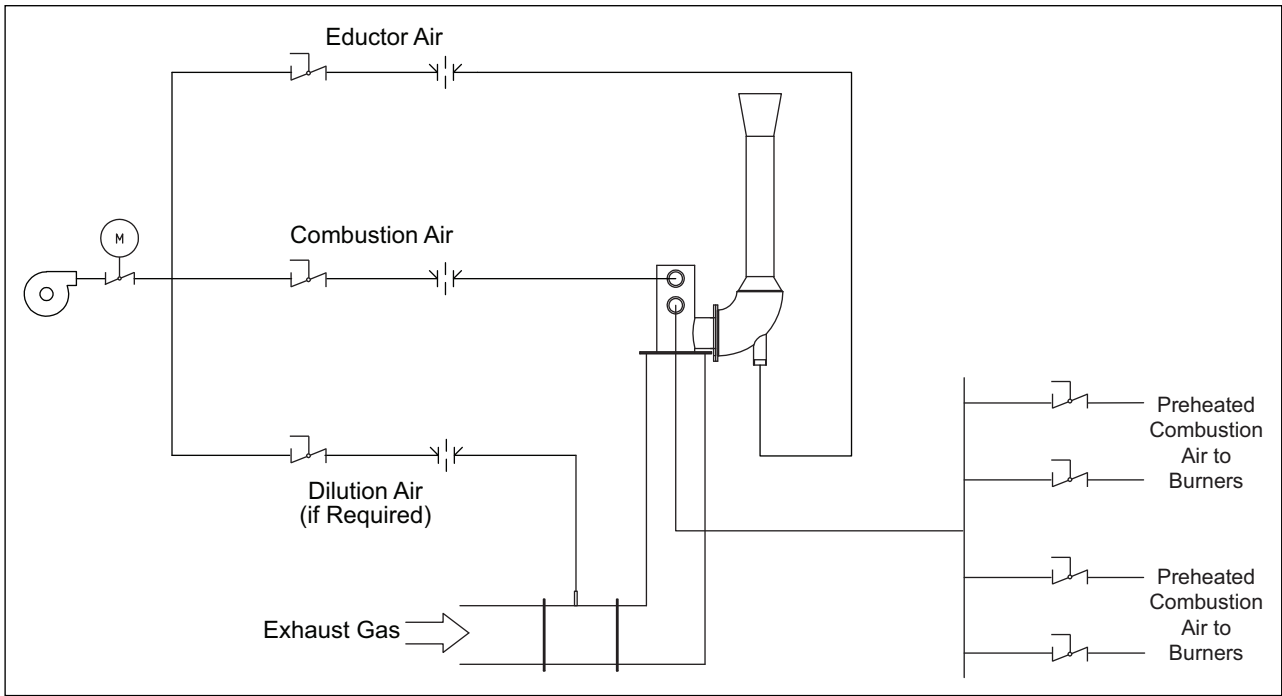

**Figure 3.4. P & ID of Typical Piping**

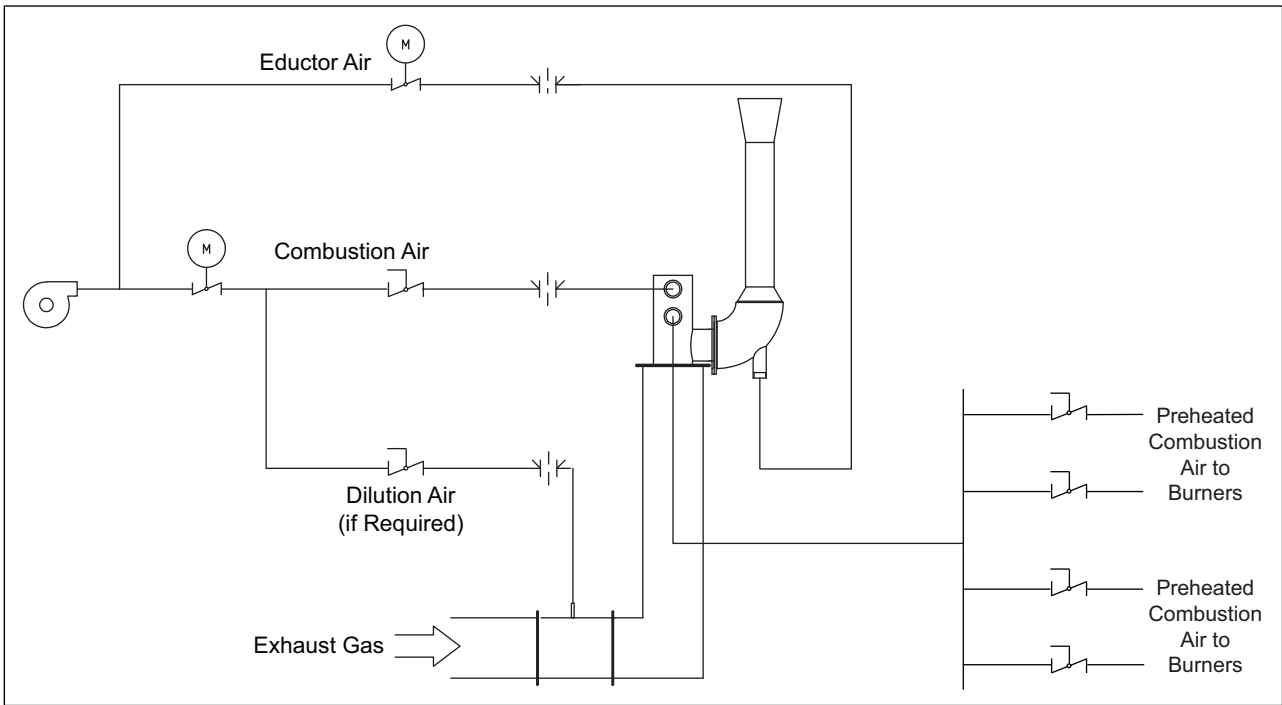

**Figure 3.5. P & ID of Typical Piping for Greater Furnace Pressure Control**



# Appendix

## Conversion Factors

### Metric to English

From	To	Multiply By
actual cubic meter/h (am <sup>3</sup> /h)	actual cubic foot/h (acfh)	35.31
normal cubic meter/h (Nm <sup>3</sup> /h)	standard cubic foot /h (scfh)	38.04
degrees Celsius (°C)	degrees Fahrenheit (°F)	(°C x 9/5) + 32
kilogram (kg)	pound (lb)	2.205
kilowatt (kW)	Btu/h	3415
meter (m)	foot (ft)	3.281
millibar (mbar)	inches water column ("w.c.)	0.402
millibar (mbar)	pounds/sq in (psi)	14.5 x 10 <sup>-3</sup>
millimeter (mm)	inch (in)	3.94 x 10 <sup>-2</sup>
MJ/Nm <sup>3</sup>	Btu/ft <sup>3</sup> (standard)	26.86







### Metric to Metric



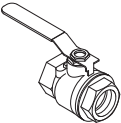
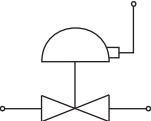
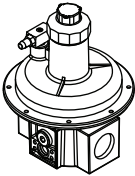
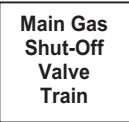

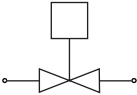
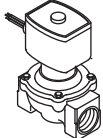



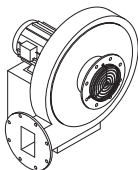

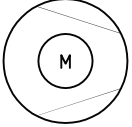
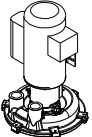
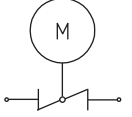
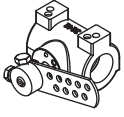
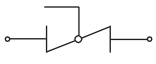
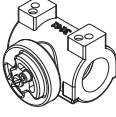
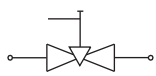

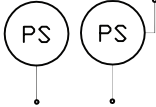
From	To	Multiply By
kiloPascals (kPa)	millibar (mbar)	10
meter (m)	millimeter (mm)	1000
millibar (mbar)	kiloPascals (kPa)	0.1
millimeter (mm)	meter (m)	0.001

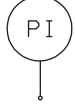
### English to Metric

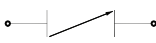
From	To	Multiply By
actual cubic foot/h (acfh)	actual cubic meter/h (am <sup>3</sup> /h)	2.832 x 10 <sup>-2</sup>
standard cubic foot /h (scfh)	normal cubic meter/h (Nm <sup>3</sup> /h)	2.629 x 10 <sup>-2</sup>
degrees Fahrenheit (°F)	degrees Celsius (°C)	(°F - 32) x 5/9
pound (lb)	kilogram (kg)	0.454
Btu/h	kilowatt (kW)	0.293 x 10 <sup>-3</sup>
foot (ft)	meter (m)	0.3048
inches water column ("w.c.)	millibar (mbar)	2.489
pounds/sq in (psi)	millibar (mbar)	68.95
inch (in)	millimeter (mm)	25.4
Btu/ft <sup>3</sup> (standard)	MJ/Nm <sup>3</sup>	37.2 x 10 <sup>-3</sup>

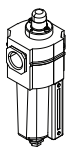
# System Schematics

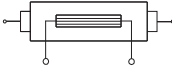
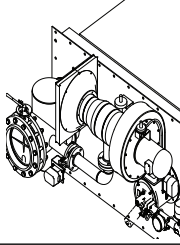
Symbol	Appearance	Name	Remarks	Bulletin/ Info Guide
		Gas Cock	Gas cocks are used to manually shut off the gas supply.	710
		Ratio Regulator	A ratio regulator is used to control the air/gas ratio. The ratio regulator is a sealed unit that adjusts the gas pressure in ratio with the air pressure. To do this, it measures the air pressure with a pressure sensing line, the impulse line. This impulse line is connected between the top of the ratio regulator and the burner body.	742
		Main Gas Shut-Off Valve Train	Eclipse strongly endorses NFPA as a minimum.	790/791
		Pilot Gas Valve Train	Eclipse strongly endorses NFPA as a minimum.	790/791
		Automatic Shut-Off Valve	Shut-off valves are used to automatically shut off the gas supply on a gas system or a burner.	760
		Orifice Meter	Orifice meters are used to measure flow.	930
		Combustion Air Blower	The combustion air blower provides the combustion air to the burner(s).	610

Symbol	Appearance	Name	Remarks	Bulletin/ Info Guide
		Hermetic Booster	Booster is used to increase gas pressure.	620
		Automatic Butterfly Valve	Automatic butterfly valves are typically used to set the output of the system.	720
		Manual Butterfly Valve	Manual butterfly valves are used to balance the air or gas flow at each burner.	720
		Adjustable Limiting Orifice	Adjustable limiting orifices are used for fine adjustment of gas flow.	728/730
		Pressure Switch	A switch activated by rise or fall in pressure. A manual reset version requires pushing a button to transfer the contacts when the pressure set point is satisfied.	840
		Pressure Gauge	A device to indicate pressure.	940
		Check Valve	A check valve permits flow only in one direction and is used to prevent back flow of gas.	780
		Strainer	A strainer traps sediment to prevent blockage of sensitive components downstream.	
		Flexible Connector	Flexible connectors isolate components from vibration, mechanical, and thermal stresses.	
		Heat Exchanger	Heat exchangers transfer heat from one medium to another.	500
		Pressure Taps	Pressure taps measure static pressure.	

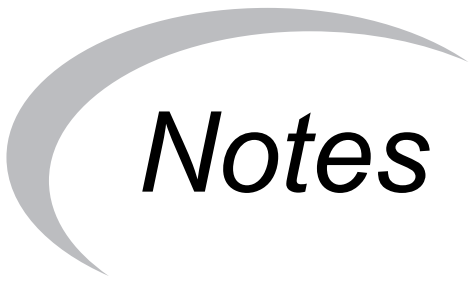

# *Notes*

