

Eclipse ExtensoHeat Lance Burners

*Model EH050
Version 1*

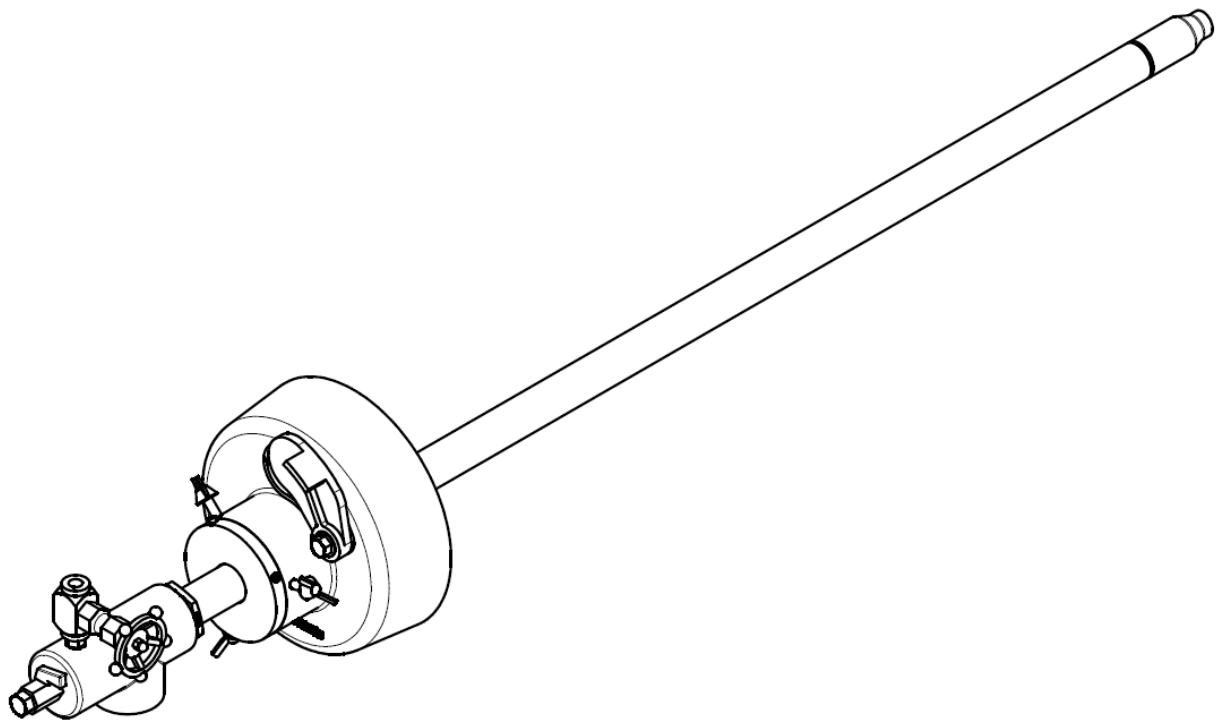

Copyright

Copyright 2007 by Eclipse, inc. All rights reserved worldwide. This publication is protected by federal regulation and shall not be copied, distributed, transmitted, transcribed or translated into any human or computer language, in any form or by any means, to any third parties, without the express written consent of Eclipse, inc.

Disclaimer Notice

In accordance with the manufacturer's policy of continual product improvement, the product presented in this brochure is subject to change without notice or obligation.

The material in this manual is believed adequate for the intended use of the product. If the product is used for purposes other than those specified herein, confirmation of validity and suitability must be obtained. Eclipse warrants that the product itself does not infringe upon any United States patents. No further warranty is expressed or implied.

Liability & Warranty

We have made every effort to make this manual as accurate and complete as possible. Should you find errors or omissions, please bring them to our attention so that we may correct them. In this way we hope to improve our product documentation for the benefit of our customers. Please send your corrections and comments to our Technical Documentation Specialist.

It must be understood that Eclipse's liability for its product, whether due to breach of warranty, negligence, strict liability, or otherwise is limited to the furnishing of replacement parts and Eclipse will not be liable for any other injury, loss, damage or expenses, whether direct or consequential, including but not limited to loss of use,

income, or damage to material arising in connection with the sale, installation, use of, inability to use, or the repair or replacement of Eclipse's products.

Any operation expressly prohibited in this manual, any adjustment, or assembly procedures not recommended or authorized in these instructions shall void the warranty.

Document Conventions

There are several special symbols in this document. You must know their meaning and importance.

The explanation of these symbols follows below. Please read it thoroughly.

How To Get Help

If you need help, contact your local Eclipse representative. You can also contact Eclipse at:

1665 Elmwood Rd.
Rockford, Illinois 61103 U.S.A.
Phone: 815-877-3031
Fax: 815-877-3336
<http://www.eclipsenet.com>

Please have the information on the product label available when contacting the factory so we may better serve you.

 ECLIPSE <small>Innovative Thermal Solutions</small>	www.eclipsenet.com
Product Name	
Item #	
S/N	
DD MMM YYYY	



This is the safety alert symbol. It is used to alert you to potential personal injunt hazards. Obey all safety messages that follow this symbol to avoid possible injury or death.



Indicates a hazardous situation which, if not avoided, will result in death or serious injury.



Indicates a hazardous situation which, if not avoided, could result in death or serious injury.



Indicates a hazardous situation which, if not avoided, could result in minor or moderate injury.

NOTICE

Is used to address practices not related to personal injury.

NOTE

Indicates an important part of text. Read thoroughly.



Table of Contents

Introduction	4
Product Description.....	4
Audience	4
ExtensoHeat Documents	4
Purpose.....	4
Safety	5
Introduction	5
Safety.....	5
Capabilities.....	5
Operator Training	5
Replacement Parts.....	5
System Design	6
Design	6
Step 1: Burner Model Selection	6
Step 2: Control Methodology.....	6
Step 3: Ignition System	7
Step 4: Flame Monitoring System.....	7
Step 5: Combustion Air System: Blower and Air Pressure Switch.....	8
Step 6: Main Gas Shut-Off Valve Train.....	8
Step 7: Process Temperature Control System.....	8
Appendix	i
Conversion Factors	i
Key to System Schematics	ii

Introduction

1

Product Description

The ExtensoHeat is a nozzle-mixing burner intended to operate in high-temperature firing kilns which have very thick walls and a very thick roof. This burner is also suitable for special applications in which the flame must be developed away from the burner.

The ExtensoHeat is designed to project the flame through the thick wall of the combustion chamber, resulting in a strong jet of hot gases within the chamber.

The high speed of the combustion gases ensure excellent temperature uniformity and high efficiency of the system. The fuel velocity reaches 328 ft/s (100 m/s), and different nozzle lengths, ranging from 31 in (800mm) to 55 in (1400mm), are available.

Burner Specifications:

- Control options include ON/OFF, Gas Modulation and Gas Pulse Firing. All constant air flow.
- Self ignition by process temperature.
- Flame detection not necessary because the temperature is above 1382°F (750°C).
- Operates with other fuels.
- Designed to operate with excess gas in chambers with an oxidizing atmosphere ($O_2 > 12\%$ vol.)

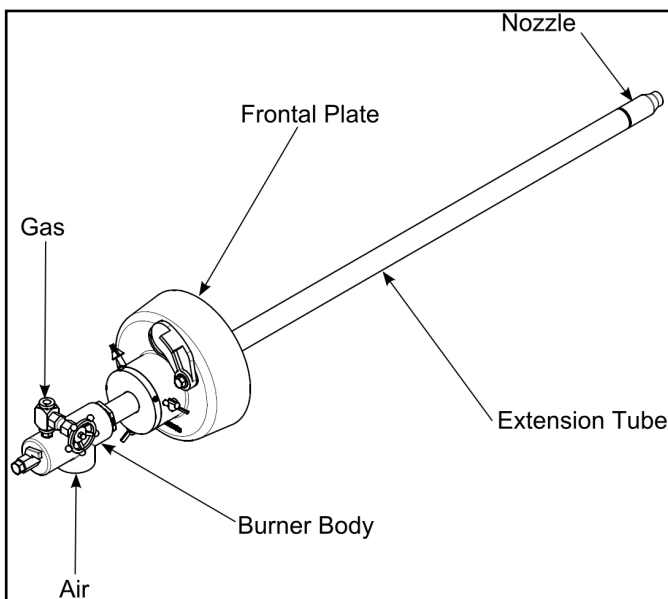

Figure 1.1. ExtensoHeat Burner

Audience

This manual has been written for people who are already familiar with all aspects of a combustion system and its add-on components, also referred to as “the burner system.”

These aspects are:

- Design / Selection
- Installation
- Use
- Maintenance

The audience is expected to have previous experience with this type of equipment.

ExtensoHeat Documents

Design Guide 235

- This document

Datasheet 235

- Required to complete design and selection

Installation Guide 235

- Used with datasheet to complete installation

Related Documents 235

- EFE 825 (Combustion Engineering Guide)
- Information Guide 610

Purpose

The purpose of this manual is to ensure the installation of a safe, effective, and trouble-free combustion system.

Safety

2

Introduction

In this section, you will find important notices about safe operation of a burner system. Read this entire manual before you attempt to start the system.

Safety

DANGER

- **The burners covered in this manual are designed to mix fuel with air and burn the resulting mixture. All fuel burning devices are capable of producing fires and explosions when improperly applied, installed, adjusted, controlled or maintained.**
- **Do not bypass any safety feature. Fires and explosions can be caused.**
- **Never try to light the burner if the burner shows signs of damage or malfunctioning.**

WARNING

- **The burner and duct sections may have HOT surfaces. Always wear protective clothing when approaching the burner.**

NOTICE

- **This manual provides information about the use of the burners for their specific design purpose. Do not deviate from any instructions or application limits described herein without written advice from Eclipse.**
- **Read this entire manual before you attempt to start the system. If you do not understand any part of the information in this manual, please contact Eclipse.**

Capabilities

Adjustment, maintenance and troubleshooting of the mechanical and electrical parts of this system should be done by qualified personnel with good mechanical aptitude and experience with combustion equipment.

Operator Training

The best safety precaution is an alert and trained operator. Thoroughly instruct new operators so they demonstrate an adequate understanding of the equipment and its operation. A regular retraining schedule should be administered to ensure operators maintain a high degree of proficiency.

Replacement Parts

Order replacement parts from Eclipse only. All Eclipse approved, customer supplied valves or switches should carry UL, FM, CSA, CGA, and/or CE approval where applicable.

System Design

3

Design

When selecting a Vortometric burner, choices are available to define a burner that will be safe and reliable for the system in which it will be installed. The design process is divided into the following steps.

1. Burner Model Selection:
 - a. Burner Size and Quantity
 - b. Fuel Type and Fuel Pressure
2. Control Methodology
 - a. Control Methods
 - b. ON/OFF Burner's Control
 - c. Burner's Gas Modulation Control
 - d. Burner's Gas Pulse Control
3. Ignition System
4. Flame Monitoring System
5. Combustion Air System: Blower and Air Pressure Switch
 - a. Effects of Atmospheric Conditions
 - b. Blower
 - c. Air Pressure Switch
6. Main Gas Shut-Off Valve Train
7. Process Temperature Control System

Step 1: Burner Model Selection

Burner Size and Quantity

Select the size and quantity of burners based on the heat required. For heat requirement calculations refer to the Combustion Engineering Guide (EFE 825).

Performance data, dimensions and specifications are given for each ExtensoHeat model in Datasheet 235.

Fuel Type and Fuel Pressure

The ExtensoHeat is capable of burning multiple fuels including Natural Gas, Propane and Butane. Consult Eclipse when considering the use of alternative fuels.

The gas pressure must be at the minimum level shown. The required gas pressure at the burner can be found in Datasheet 235.

Step 2: Control Methodology

The chosen control methodology depends on the type of process to be controlled.

NOTE: The stated operational characteristics only apply if the described control circuits are followed. Use of different control methods will result in unknown operational performance characteristics. Use the control circuits contained within this section or contact Eclipse for written, approved alternatives.

Control Methods

Three possible types of power regulation are available for this equipment: ON/OFF Control, Gas Modulation and Gas Pulse Control. Eclipse only recommends Pulse Control for an ExtensoHeat system if there are safety solenoid valves available which operate at least 1,000,000 cycles.



CAUTION

- **The control methods explained below do not show the burner safety system. Any decision regarding the use and/or type of safeties should be made in accordance with local safety and/or insurance standards.**

Burner operation should only take place when the kiln cars are not moving. This ensures that the burner flame will always be injected between the wagons or cars.

The blower providing the air should be in operation at all times. The "car advance" contact must shut off the gas and close the air to the burners in order to automatically protect the load. The air flow control valve ❶ should close when the cars advance and open again when they are stopped. Normal burner operation can be resumed at that time. Cooling air circulation should be done via the bypass piping ❷.

The temperature control sensor must be located in the direction of the downstream flow of the burner or group of burners.

To obtain good control during each car advance, the temperature controller must hold the current level of the control signal.

ON/OFF Burner's Control

The system controls the temperature in cycles, simultaneously opening and closing the general gas solenoid valve ⑤ within each cycle in conjunction with the requirements. All burners are set by manual balancing valves ④. See Figure 3.1.

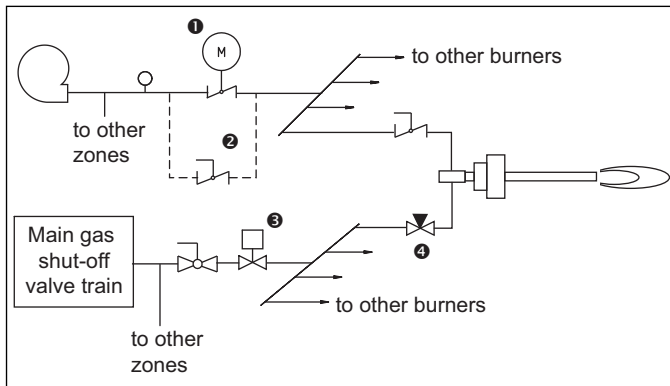

Figure 3.1. ON/OFF Gas Control. Constant Air

Burner's Gas Modulation Control

A modulating burner system provides a proportional output to the demands of the process. ANY input between "high fire" and "low fire" is possible.

Control takes place via 4 – 20 mA output current which proportionally opens or closes a motorized valve ⑤, which then controls gas supply to the entire group. See Figure 3.2.

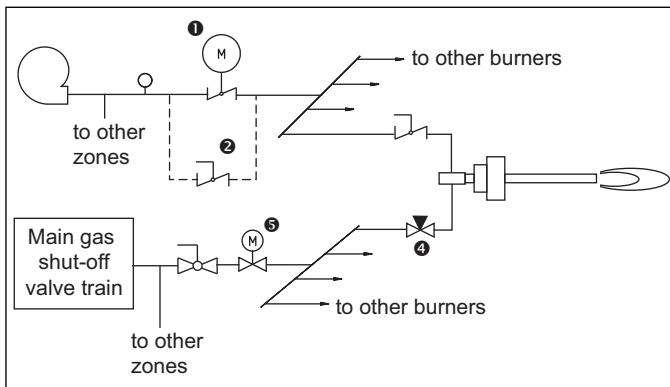

Figure 3.2. Modulating Gas Control. Constant Air

Burner's Gas Pulse Control

This control is used to regulate the timing of a sequential activation of the gas ON/OFF solenoid valves ⑥ located at each burner. This control requires individual adjustment of the control system times. See Figure 3.3.

NOTE: The order sequence of the valve activation may vary depending on the control design.

Always check that the maximum operating pressure of the valve is sufficient for the circuit where it is installed.

Verify that the control solenoid valves' life overcomes the expectations in conjunction with the controls cycle that has been selected.

Two variants of Pulse Control are possible:

1. Varying cycle time: Solenoid valves' ⑥ open time is fixed. The solenoid valves open/close cycle time will oscillate proportionally in conjunction with the deviation between the set temperature and the actual temperature.
2. Varying solenoid valves activation time: Cycle time is fixed. The solenoid valves ⑥ will open or close during a controlled time. The open time of the valves will oscillate by control depending on temperature.

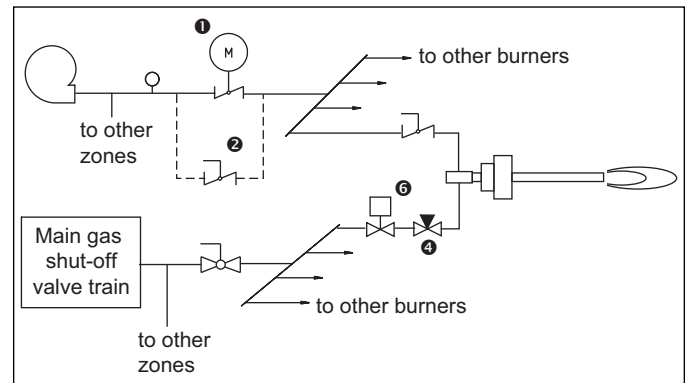

Figure 3.3. Gas Pulse Control. Constant Air

Step 3: Ignition System

Self-Ignition

ExtensoHeat burners are designed to work under gas auto ignition conditions; therefore an ignition system is not required.

NOTE: Minimum process temperature may be different depending on the gas used and the applicable local standards.

Step 4: Flame Monitoring System

Flame Inspection

There is no flame monitoring system due to the burner's intrinsic characteristics, however, an inspection clapper is included for periodic checks.

NOTICE

- Installation requires an external safety system to ensure minimum operating temperature in accordance with local standards.

Step 5: Combustion Air System: Blower and Air Pressure Switch

Effects of Atmospheric Conditions

Blower data is based on the International Standard Atmosphere (ISA) at Mean Sea Level (MSL), which means it is valid for:

- Sea level
- 29.92" Hg (1013 mbar)
- 70°F (21°C)

The makeup of air is different above sea level or in a hot environment. Here, the density of the air decreases, and, as a result, the outlet pressure and the flow of the blower decrease. An accurate description of these effects is in the Eclipse Engineering Guide (EFE 825). The Guide contains tables to calculate the effect of pressure, altitude and temperature on air.

Blower

The rating of the blower must match the system requirements. You can find all the blower data in Information Guide 610.

Follow these steps:

1. Calculate the outlet pressure. When calculating the required outlet pressure of the blower, the total of these pressures must be calculated.
 - The static air pressure required at the burner
 - The total pressure drop in the piping
 - The total of the pressure drops across the valves
 - The pressure in the chamber (suction or pressurized)
 - A minimum safety margin of 10%
2. Calculate the required flow. The blower output is the air flow delivered under standard atmospheric conditions. It must be enough to feed all the burners in the system at high fire.

Air Pressure Switch

The air pressure switch gives a signal to the monitoring system when there is not enough air pressure from the blower.



- Eclipse supports NFPA regulations, which requires the use of an air pressure switch in conjunction with other safety components as a minimum standard for main gas safety shut-off systems.

Step 6: Main Gas Shut-Off Valve Train

Consult Eclipse

Eclipse can help you design and obtain a main gas shut-off valve train that complies with the current safety standards. The shut-off valve train must comply with all the local safety standards set by the authorities that have jurisdiction. For details, please contact Eclipse.

NOTE: Eclipse recommends two shut-off valves as a minimum standard for main gas safety shut-off systems as required by North American NFPA and European EN regulations.

Step 7: Process Temperature Control System

Consult Eclipse

The process temperature control system is used to control and monitor the temperature of the system. There is a wide variety of control and measuring equipment available. For details, please contact Eclipse.



Appendix

Conversion Factors

Metric to English

From	To	Multiply By
actual cubic meter/h (am ³ /h)	actual cubic foot/h (acfh)	35.31
normal cubic meter/h (Nm ³ /h)	standard cubic foot /h (scfh)	38.04
degrees Celsius (°C)	degrees Fahrenheit (°F)	(°C x 9/5) + 32
kilogram (kg)	pound (lb)	2.205
kilowatt (kW)	Btu/h	3415
meter (m)	foot (ft)	3.281
millibar (mbar)	inches water column ("w.c.)	0.402
millibar (mbar)	pounds/sq in (psi)	14.5 x 10 ⁻³
millimeter (mm)	inch (in)	3.94 x 10 ⁻²
MJ/Nm ³	Btu/ft ³ (standard)	26.86

Metric to Metric







From	To	Multiply By
kiloPascals (kPa)	millibar (mbar)	10
meter (m)	millimeter (mm)	1000
millibar (mbar)	kiloPascals (kPa)	0.1
millimeter (mm)	meter (m)	0.001



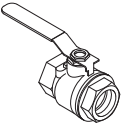
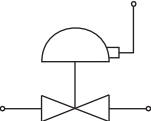
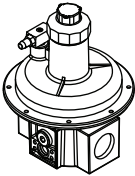
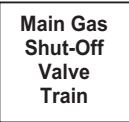

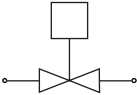
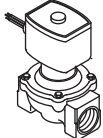



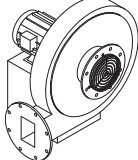

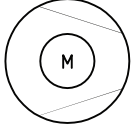
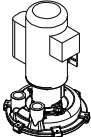
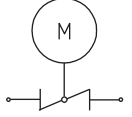
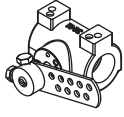
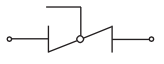
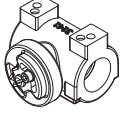
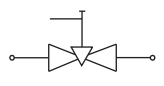

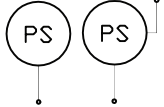
English to Metric

From	To	Multiply By
actual cubic foot/h (acfh)	actual cubic meter/h (am ³ /h)	2.832 x 10 ⁻²
standard cubic foot /h (scfh)	normal cubic meter/h (Nm ³ /h)	2.629 x 10 ⁻²
degrees Fahrenheit (°F)	degrees Celsius (°C)	(°F - 32) x 5/9
pound (lb)	kilogram (kg)	0.454
Btu/h	kilowatt (kW)	0.293 x 10 ⁻³
foot (ft)	meter (m)	0.3048
inches water column ("w.c.)	millibar (mbar)	2.489
pounds/sq in (psi)	millibar (mbar)	68.95
inch (in)	millimeter (mm)	25.4
Btu/ft ³ (standard)	MJ/Nm ³	37.2 x 10 ⁻³

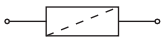
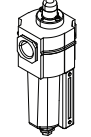

System Schematics

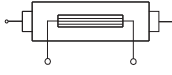
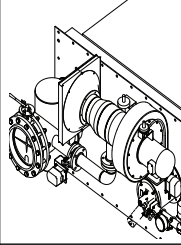
Symbol	Appearance	Name	Remarks	Bulletin/ Info Guide
		Gas Cock	Gas cocks are used to manually shut off the gas supply.	710
		Ratio Regulator	A ratio regulator is used to control the air/gas ratio. The ratio regulator is a sealed unit that adjusts the gas pressure in ratio with the air pressure. To do this, it measures the air pressure with a pressure sensing line, the impulse line. This impulse line is connected between the top of the ratio regulator and the burner body.	742
		Main Gas Shut-Off Valve Train	Eclipse strongly endorses NFPA as a minimum.	790/791
		Pilot Gas Valve Train	Eclipse strongly endorses NFPA as a minimum.	790/791
		Automatic Shut-Off Valve	Shut-off valves are used to automatically shut off the gas supply on a gas system or a burner.	760
		Orifice Meter	Orifice meters are used to measure flow.	930
		Combustion Air Blower	The combustion air blower provides the combustion air to the burner(s).	610

Symbol	Appearance	Name	Remarks	Bulletin/ Info Guide
		Hermetic Booster	Booster is used to increase gas pressure.	620
		Automatic Butterfly Valve	Automatic butterfly valves are typically used to set the output of the system.	720
		Manual Butterfly Valve	Manual butterfly valves are used to balance the air or gas flow at each burner.	720
		Adjustable Limiting Orifice	Adjustable limiting orifices are used for fine adjustment of gas flow.	728/730
		Pressure Switch	A switch activated by rise or fall in pressure. A manual reset version requires pushing a button to transfer the contacts when the pressure set point is satisfied.	840
		Pressure Gauge	A device to indicate pressure.	940
		Check Valve	A check valve permits flow only in one direction and is used to prevent back flow of gas.	780
		Strainer	A strainer traps sediment to prevent blockage of sensitive components downstream.	
		Flexible Connector	Flexible connectors isolate components from vibration, mechanical, and thermal stresses.	
		Heat Exchanger	Heat exchangers transfer heat from one medium to another.	500
		Pressure Taps	Pressure taps measure static pressure.	

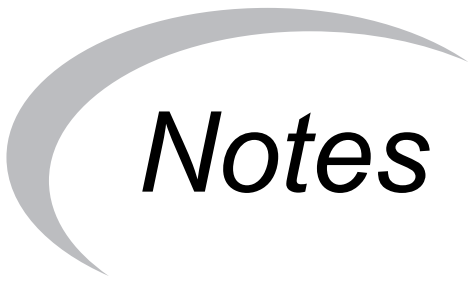

Notes

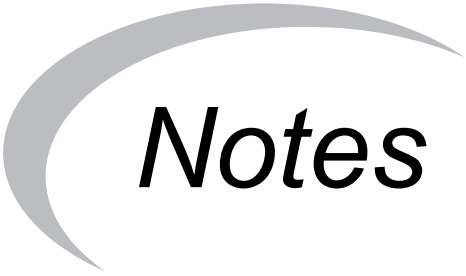

Notes

